

HCI634K - Technical Data Sheet

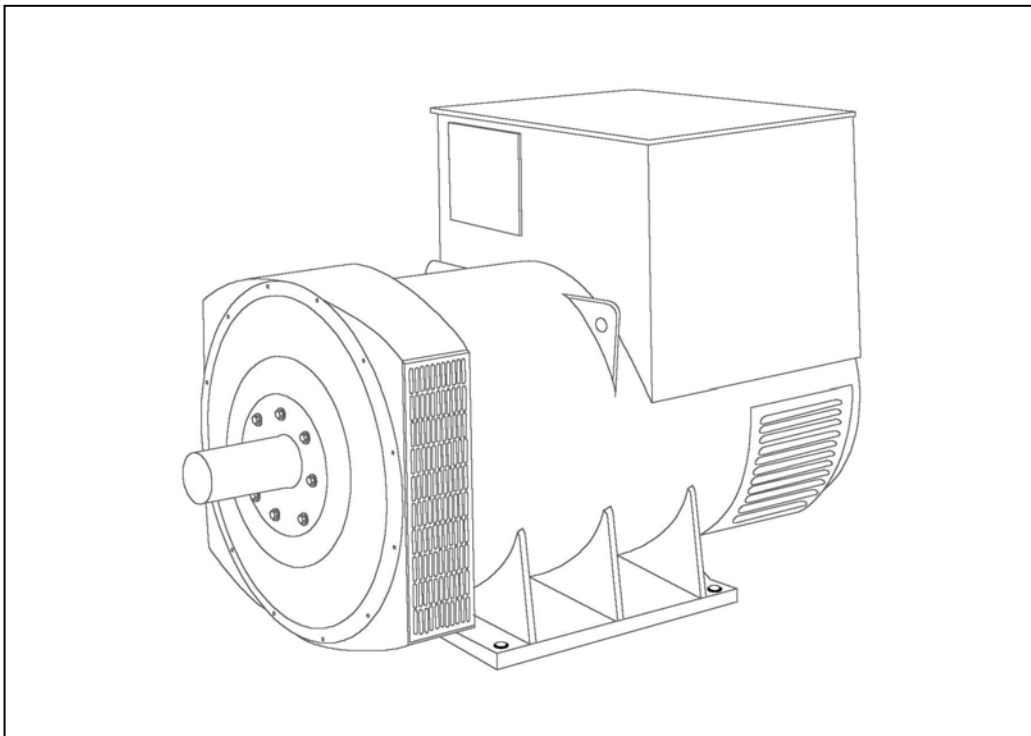

If you need more information please visit: www.plantaselectricasdemexico.com
e-mail: ventas@plantaselectricasdemexico.com

HCI634K

SPECIFICATIONS & OPTIONS



STANDARDS

Newage Stamford industrial generators meet the requirements of BS EN 60034 and the relevant section of other international standards such as BS5000, VDE 0530, NEMA MG1-32, IEC34, CSA C22.2-100, AS1359. Other standards and certifications can be considered on request.

VOLTAGE REGULATORS

MX321 AVR - STANDARD

This sophisticated Automatic Voltage Regulator (AVR) is incorporated into the Stamford Permanent Magnet Generator (PMG) system and is fitted as standard to generators of this type.

The PMG provides power via the AVR to the main exciter, giving a source of constant excitation power independent of generator output. The main exciter output is then fed to the main rotor, through a full wave bridge, protected by a surge suppressor. The AVR has in-built protection against sustained over-excitation, caused by internal or external faults. This de-excites the machine after a minimum of 5 seconds.

Over voltage protection is built-in and short circuit current level adjustments is an optional facility.

WINDINGS & ELECTRICAL PERFORMANCE

All generator stators are wound to 2/3 pitch. This eliminates triplen (3rd, 9th, 15th ...) harmonics on the voltage waveform and is found to be the optimum design for trouble-free supply of non-linear loads. The 2/3 pitch design avoids excessive neutral currents sometimes seen with higher winding pitches, when in parallel with the mains. A fully connected damper winding reduces oscillations during paralleling. This winding, with the 2/3 pitch and carefully selected pole and tooth designs, ensures very low waveform distortion.

TERMINALS & TERMINAL BOX

Standard generators feature a main stator with 6 ends brought out to the terminals, which are mounted on the frame at the non-drive end of the generator. A sheet steel terminal box contains the AVR and provides ample space for the customers' wiring and gland arrangements. It has removable panels for easy access.

SHAFT & KEYS

All generator rotors are dynamically balanced to better than BS6861:Part 1 Grade 2.5 for minimum vibration in operation. Two bearing generators are balanced with a half key.

INSULATION/IMPREGNATION

The insulation system is class 'H'.

All wound components are impregnated with materials and processes designed specifically to provide the high build required for static windings and the high mechanical strength required for rotating components.

QUALITY ASSURANCE

Generators are manufactured using production procedures having a quality assurance level to BS EN ISO 9001.

The stated voltage regulation may not be maintained in the presence of certain radio transmitted signals. Any change in performance will fall within the limits of Criteria 'B' of EN 61000-6-2:2001. At no time will the steady-state voltage regulation exceed 2%.

NB Continuous development of our products entitles us to change specification details without notice, therefore they must not be regarded as binding.

Front cover drawing typical of product range.

If you need more information please visit: www.plantaselectricasdemexico.com
e-mail: ventas@plantaselectricasdemexico.com

HCI634K
WINDING 312

CONTROL SYSTEM	SEPARATELY EXCITED BY P.M.G.		
A.V.R.	MX321		
VOLTAGE REGULATION	± 0.5 %	With 4% ENGINE GOVERNING	
SUSTAINED SHORT CIRCUIT	REFER TO SHORT CIRCUIT DECREMENT CURVES (page 7)		

INSULATION SYSTEM	CLASS H							
PROTECTION	IP23							
RATED POWER FACTOR	0.8							
STATOR WINDING	DOUBLE LAYER LAP							
WINDING PITCH	TWO THIRDS							
WINDING LEADS	6							
STATOR WDG. RESISTANCE	0.002 Ohms PER PHASE AT 22°C STAR CONNECTED							
ROTOR WDG. RESISTANCE	2.36 Ohms at 22°C							
R.F.I. SUPPRESSION	BS EN 61000-6-2 & BS EN 61000-6-4, VDE 0875G, VDE 0875N. refer to factory for others							
WAVEFORM DISTORTION	NO LOAD < 1.5% NON-DISTORTING BALANCED LINEAR LOAD < 5.0%							
MAXIMUM OVERSPEED	2250 Rev/Min							
BEARING DRIVE END	BALL. 6224 (ISO)							
BEARING NON-DRIVE END	BALL. 6317 (ISO)							
	1 BEARING				2 BEARING			
WEIGHT COMP. GENERATOR	2541 kg				2581 kg			
WEIGHT WOUND STATOR	1294 kg				1294 kg			
WEIGHT WOUND ROTOR	1093 kg				1048 kg			
WR ² INERTIA	26.5295 kgm ²				25.9823 kgm ²			
SHIPPING WEIGHTS in a crate	2601kg				2622kg			
PACKING CRATE SIZE	194 x 92 x 147(cm)				194 x 92 x 147(cm)			
	50 Hz				60 Hz			
TELEPHONE INTERFERENCE	THF<2%				TIF<50			
COOLING AIR	1.614 m ³ /sec 3420 cfm				1.961 m ³ /sec 4156 cfm			
VOLTAGE STAR	380/220	400/231	415/240	440/254	416/240	440/254	460/266	480/277
VOLTAGE DELTA	220	230	240	254	240	254	266	277
kVA BASE RATING FOR REACTANCE VALUES	1110	1110	1110	1110	1275	1338	1388	1438
X _d DIR. AXIS SYNCHRONOUS	2.78	2.51	2.33	2.07	3.20	3.00	2.85	2.71
X' _d DIR. AXIS TRANSIENT	0.22	0.20	0.19	0.17	0.26	0.24	0.23	0.22
X'' _d DIR. AXIS SUBTRANSIENT	0.16	0.14	0.13	0.12	0.18	0.17	0.16	0.15
X _q QUAD. AXIS REACTANCE	1.63	1.47	1.37	1.21	1.88	1.76	1.67	1.59
X'' _q QUAD. AXIS SUBTRANSIENT	0.23	0.21	0.20	0.17	0.27	0.25	0.24	0.23
X _L LEAKAGE REACTANCE	0.08	0.07	0.06	0.06	0.09	0.08	0.08	0.07
X ₂ NEGATIVE SEQUENCE	0.22	0.20	0.19	0.17	0.26	0.24	0.23	0.22
X ₀ ZERO SEQUENCE	0.03	0.02	0.02	0.02	0.03	0.03	0.03	0.03
REACTANCES ARE SATURATED VALUES ARE PER UNIT AT RATING AND VOLTAGE INDICATED								
T' _d TRANSIENT TIME CONST.	0.185							
T'' _d SUB-TRANSTIME CONST.	0.025							
T' _{do} O.C. FIELD TIME CONST.	3.4							
T _a ARMATURE TIME CONST.	0.049							
SHORT CIRCUIT RATIO	1/X _d							

If you need more information please visit: www.plantaselectricasdemexico.com
e-mail: ventas@plantaselectricasdemexico.com

**50
Hz**

HCI634K
Winding 312



THREE PHASE EFFICIENCY CURVES

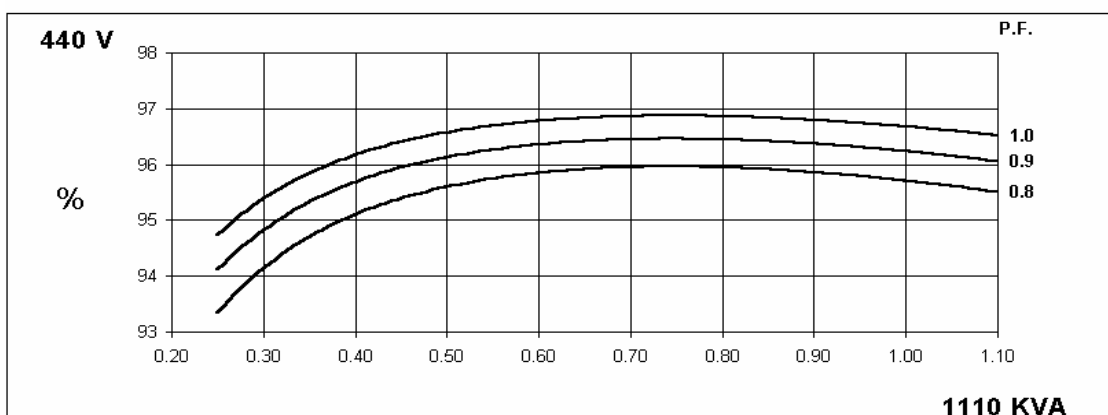
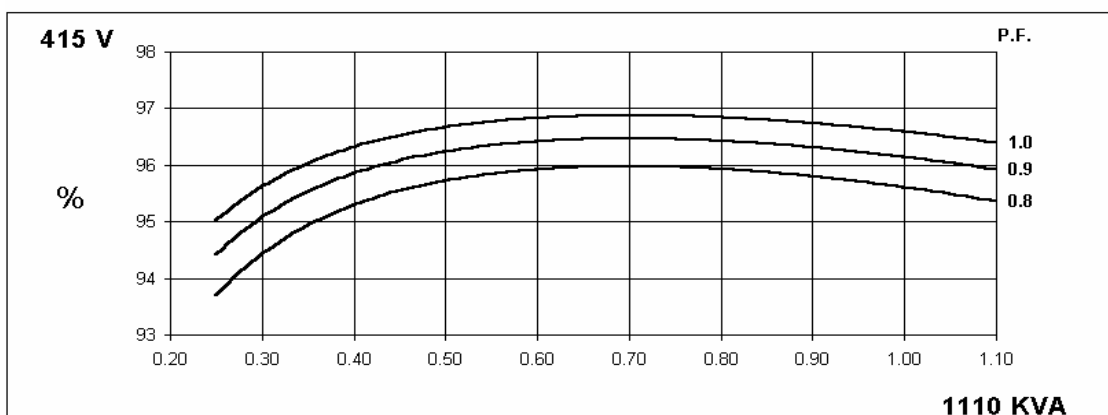
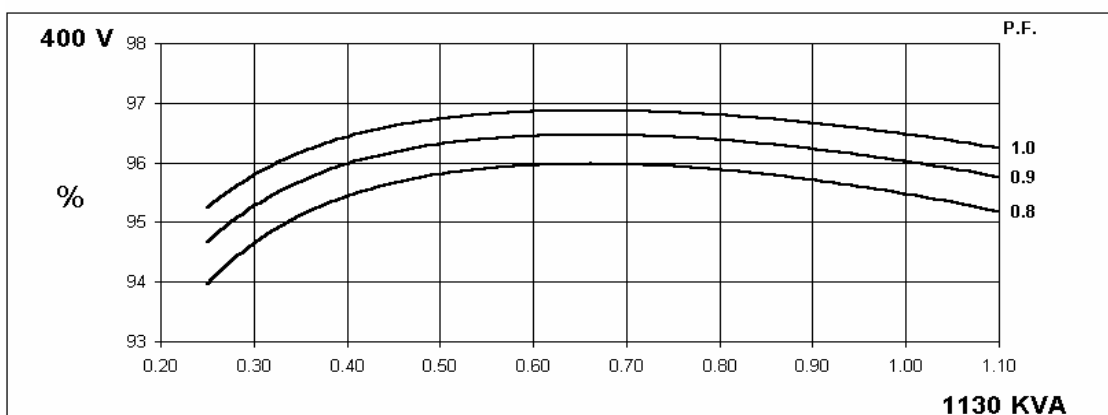
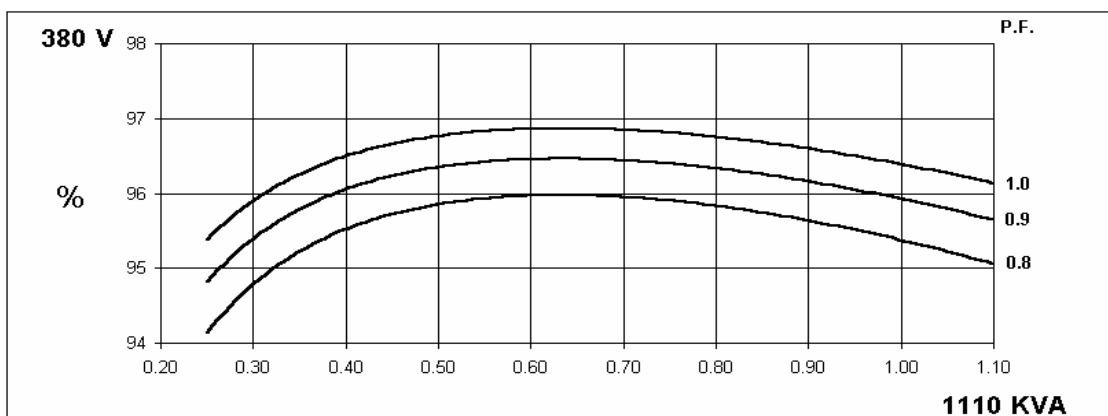

THREE PHASE EFFICIENCY CURVES

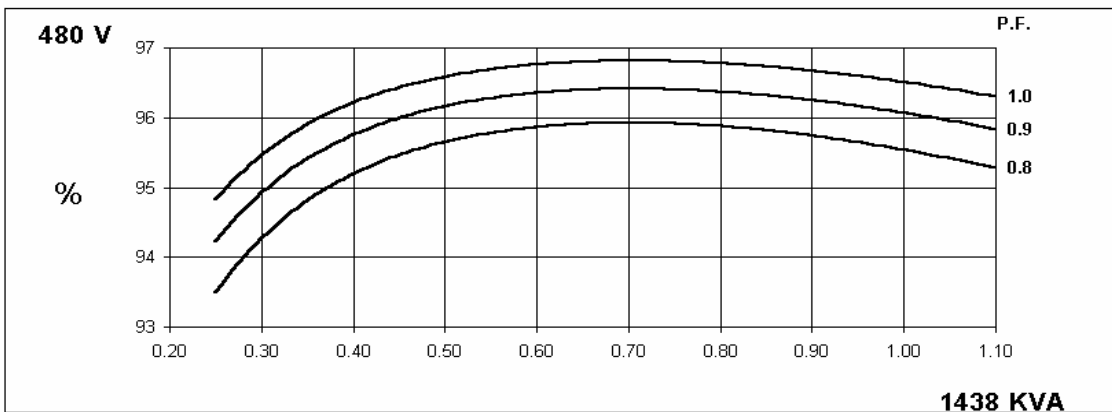
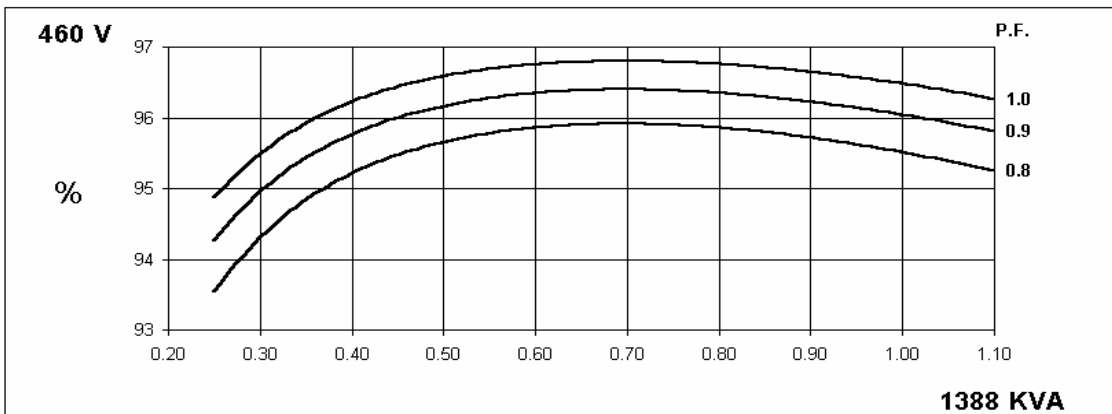
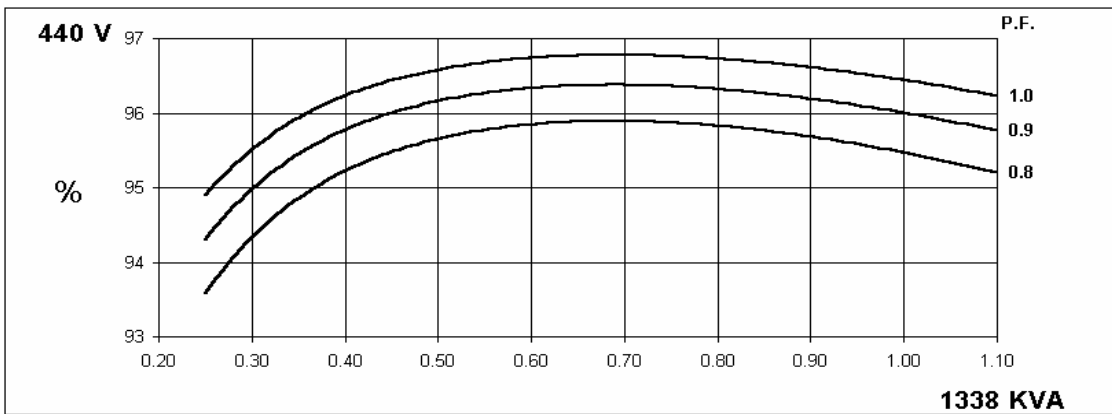
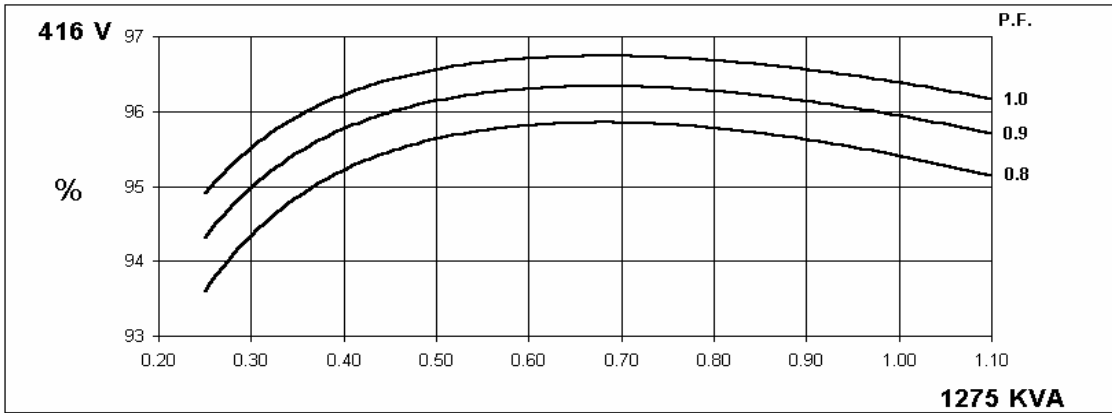

HCI634K

Winding 312



Locked Rotor Motor Starting Curve

**50
Hz**

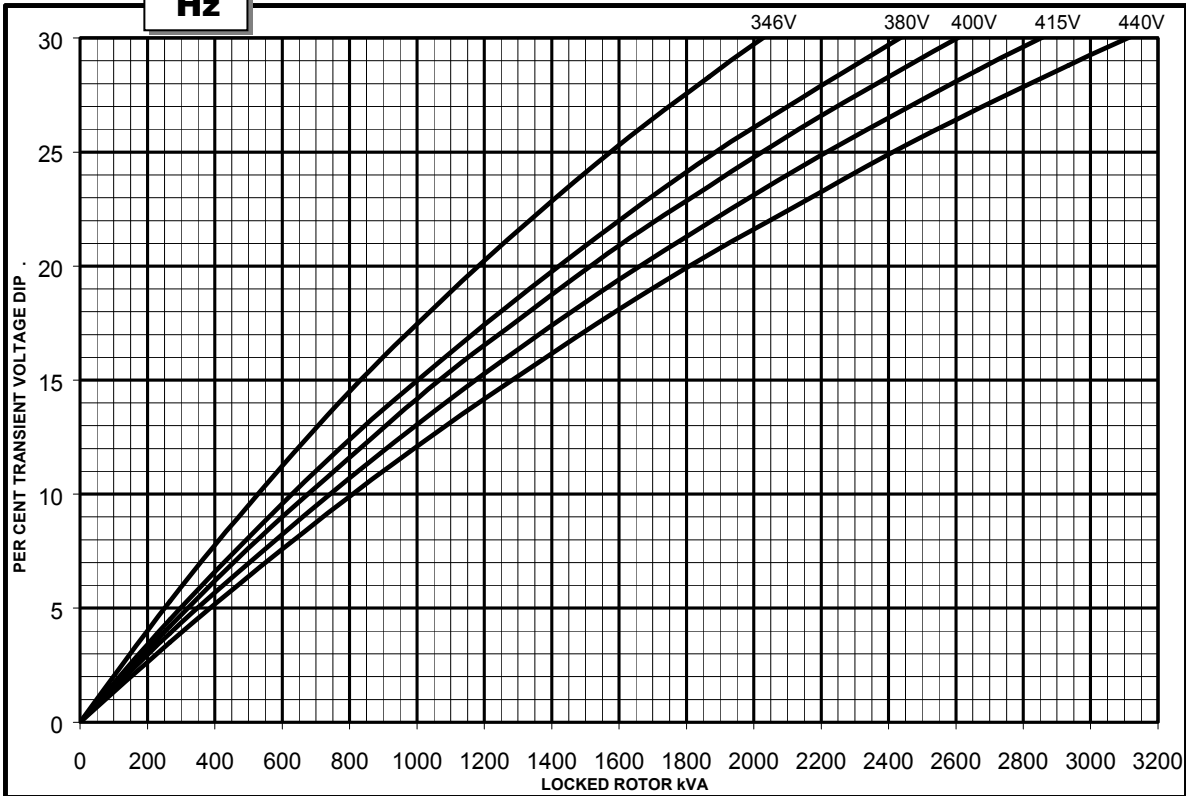

**60
Hz**

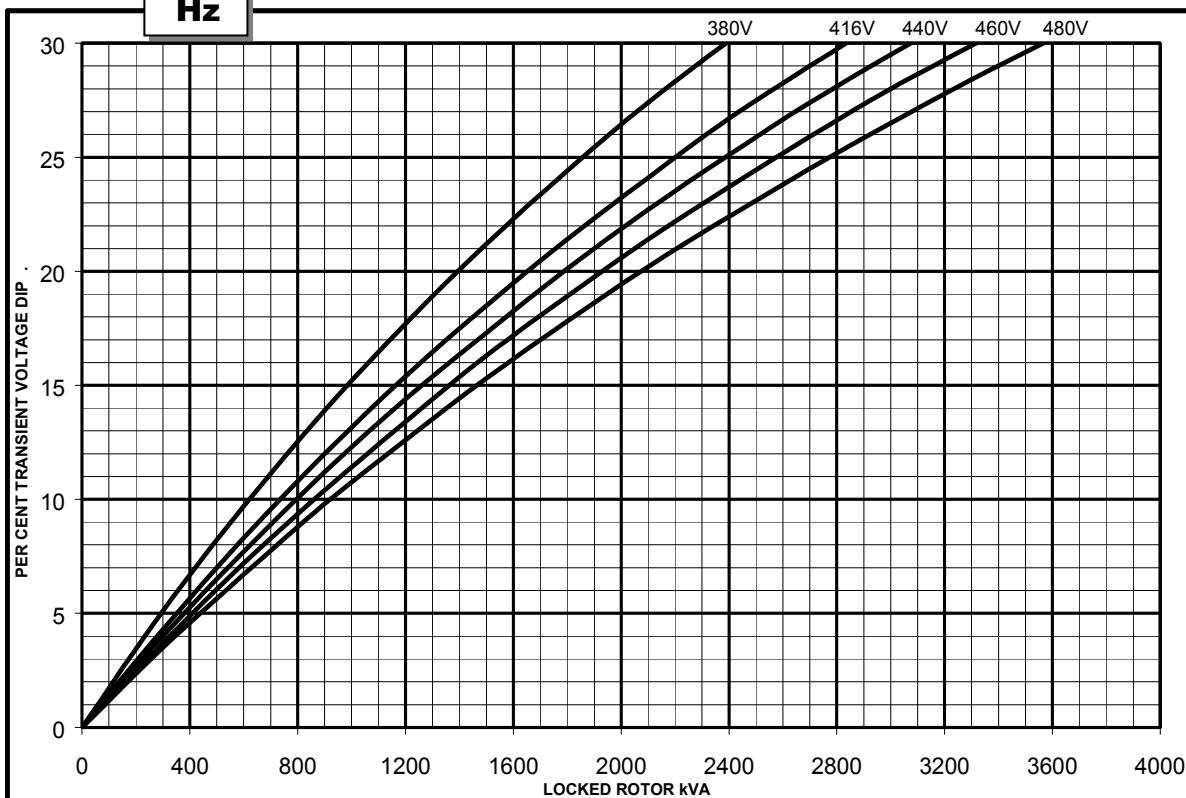

**Three-phase Short Circuit Decrement Curve. No-load Excitation at Rated Speed
Based on star (wye) connection.**

**50
Hz**

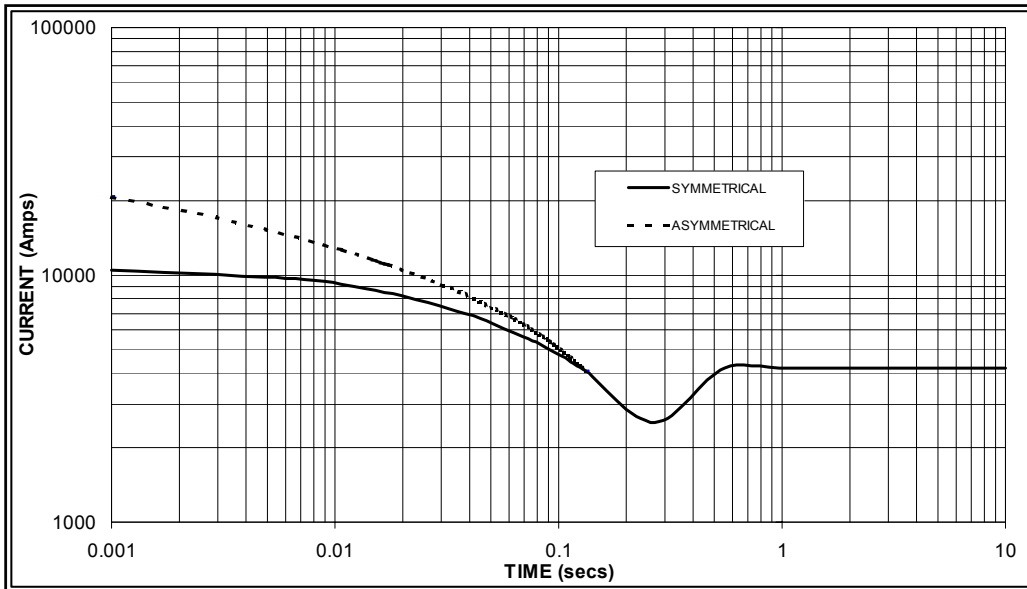

Sustained Short Circuit = 4,200 Amps

**60
Hz**

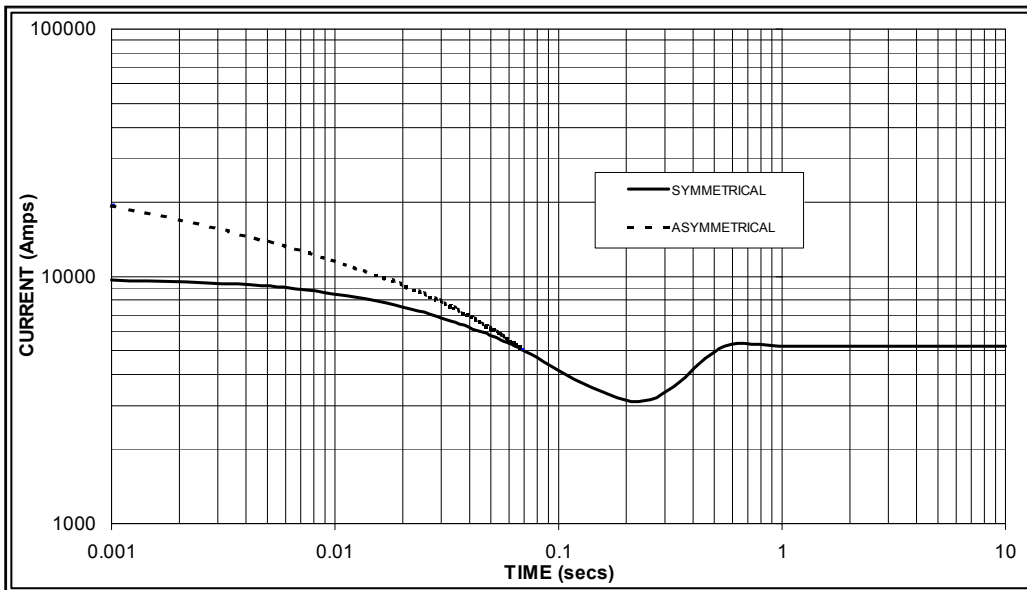

Sustained Short Circuit = 5,200 Amps

Note 1

The following multiplication factors should be used to adjust the values from curve between time 0.001 seconds and the minimum current point in respect of nominal operating voltage :

50Hz		60Hz	
Voltage	Factor	Voltage	Factor
380v	X 1.00	416v	x 1.00
400v	X 1.07	440v	x 1.06
415v	X 1.12	460v	x 1.12
440v	X 1.18	480v	x 1.17

The sustained current value is constant irrespective of voltage level

Note 2

The following multiplication factor should be used to convert the values calculated in accordance with NOTE 1 to those applicable to the various types of short circuit :

	3-phase	2-phase L-L	1-phase L-N
Instantaneous	x 1.00	x 0.87	x 1.30
Minimum	x 1.00	x 1.80	x 3.20
Sustained	x 1.00	x 1.50	x 2.50
Max. sustained duration	10 sec.	5 sec.	2 sec.

All other times are unchanged

Note 3

Curves are drawn for Star (Wye) connected machines.

HCI634K

Winding 312 0.8 Power Factor



RATINGS

Class - Temp Rise	Cont. F - 105/40°C				Cont. H - 125/40°C				Standby - 150/40°C				Standby - 163/27°C				
50Hz	Star (V)	380	400	415	440	380	400	415	440	380	400	415	440	380	400	415	440
	Delta (V)	220	230	240	254	220	230	240	254	220	230	240	254	220	230	240	254
	kVA	1000	1018	1000	1000	1110	1130	1110	1110	1180	1190	1180	1180	1220	1230	1220	1220
	kW	800	814	800	800	888	904	888	888	944	952	944	944	976	984	976	976
	Efficiency (%)	95.6	95.7	95.8	95.9	95.4	95.5	95.6	95.7	95.2	95.3	95.5	95.6	95.1	95.2	95.4	95.5
	kW Input	837	851	835	834	931	947	929	928	992	999	988	987	1026	1034	1023	1022

60Hz	Star (V)	416	440	460	480	416	440	460	480	416	440	460	480	416	440	460	480
	Delta (V)	240	254	266	277	240	254	266	277	240	254	266	277	240	254	266	277
	kVA	1188	1238	1275	1313	1275	1338	1388	1438	1350	1413	1469	1525	1400	1463	1519	1575
	kW	950	990	1020	1050	1020	1070	1110	1150	1080	1130	1175	1220	1120	1170	1215	1260
	Efficiency (%)	95.6	95.6	95.7	95.7	95.4	95.5	95.5	95.5	95.3	95.3	95.4	95.4	95.1	95.2	95.3	95.3
	kW Input	994	1036	1066	1098	1069	1121	1163	1205	1133	1186	1232	1279	1178	1229	1275	1322

DIMENSIONS

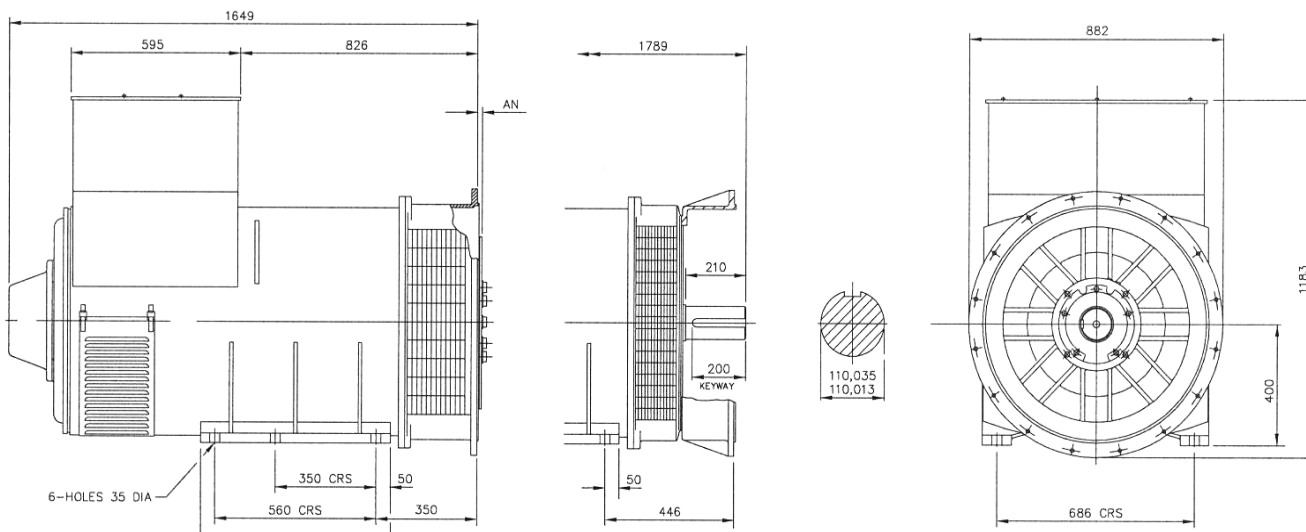

SAE	14	18	21	24
AN	25.4	15.87	0	0



PO Box 17 • Barnack Road • Stamford • Lincolnshire • PE9 2NB

Tel: 00 44 (0)1780 484000 • Fax: 00 44 (0)1780 484100

Website: www.newage-avkseg.com

© 2002 Newage International Limited.
Reprinted with permission of N.I. only.
Printed in England.

If you need more information please visit: www.plantaselectricasdemexico.com
e-mail: ventas@plantaselectricasdemexico.com

TD_HCI634K.GB_08.02_01_GB